















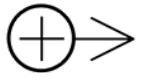
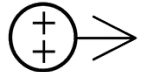

Legend

Security		Safety lock
		Medical container
		Escape route glowing
		Motion detector
		Anti-panic lock
Brand Symbol		Fire extinguisher
		Grease extinguisher
		Smoke (warning) detector
		Heat (warning) detector
		Smoke protection door
		Fire-retardant smoke protection door
Technology		Hole drilling
		Hole drilling (2x)
		Acoustic panels
		Supply and wastewater
		Outdoor light
		Computer workstation light
		Light motion detector

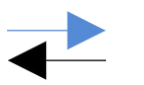
Additional information

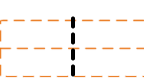
Minimum distance from radiators

For liability reasons, a minimum distance of at least 50cm from the electric heater must be maintained!

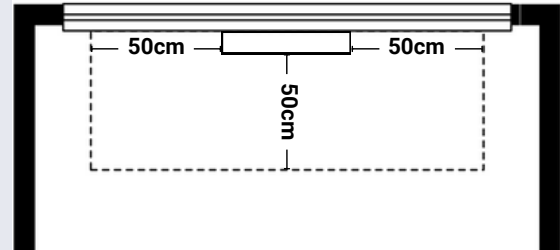

connections



Power connection
CEE 32A-5p



Supply and wastewater

- Inlet 3/4 inch
- Drain: HT pipe DN100

For kitchen connection only: HT pipe DN50

Window



Additional windows
→ installed later

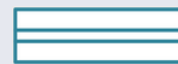

Special windows

- installed later
- Escape route window
 - Floor-to-ceiling window

Doors

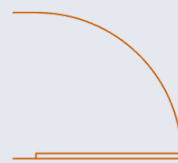

Standard exterior door

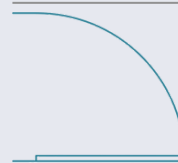

Aluminum exterior door

*optional with light cutout

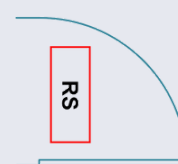





Aluminum interior door

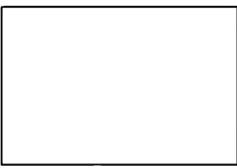

→ smokeproof

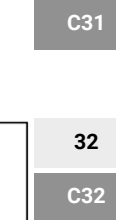
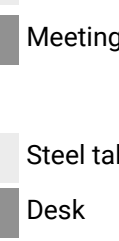

Stay

	31 Steel table
	C31 Meeting table
	32 Steel table
	C32 Desk
	C_ERG32 Ergonomics desk
	43/46 Stacking chair
	C43 Visitor chair
	42 Office swivel chair (w/o armrests)
	C42 Office swivel chair
	C_ERG42 Ergonomics swivel chair
	61 Steel single bed
	C61 Single bed 90x200 cm
	61 Bunk bed (2x Steel bed)

Cabinets and shelves

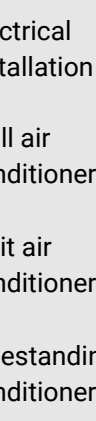
	11 Steel clothes locker
	C11 Steel clothes locker
	16 Metal roll container
	C16 Roll container
	24 Steel filing cabinet (h 120)
	C24 Sideboard
	23/25 Steel filing cabinet (h 178)
	C25 Roll-up door filing cabinet

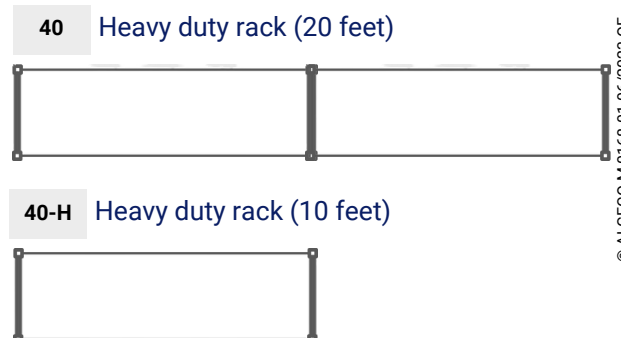
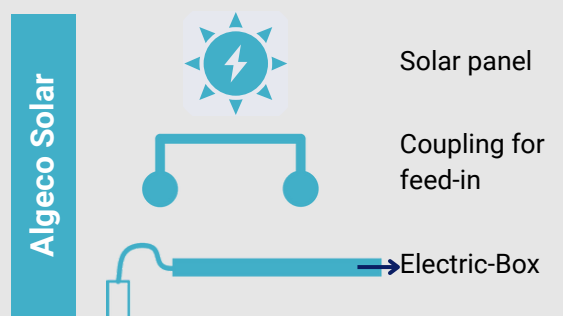
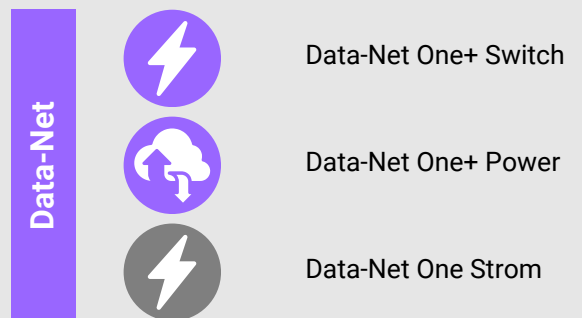
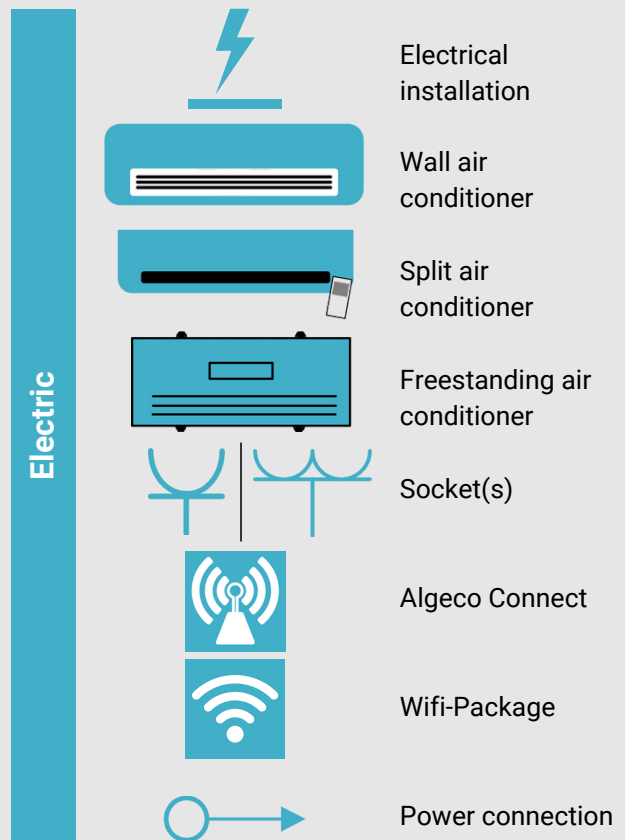

Household

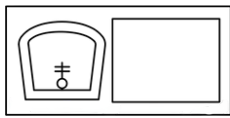

185 Changing table



912 Hand wash basin

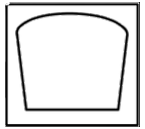

/ Sink

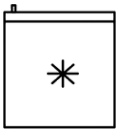

71 Refrigerator

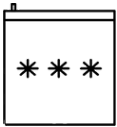

71-G Fridge with freezer

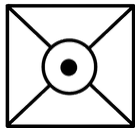

124-G Dishwasher large (60cm)

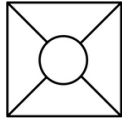

124 Dishwasher small (45cm)

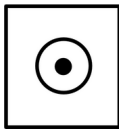

133 Washing machine

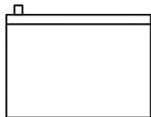

70W Microwave

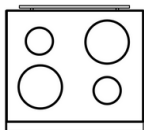

HERD Electric stove

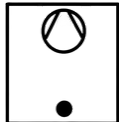

134 Tumble dryer

Kitchens

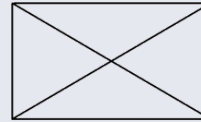

P_124 Kitchen wall cupboard

QS28 Kitchen wall cupboard

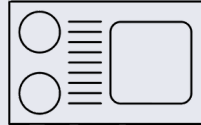

QS25 Combi kitchen

QS26 Stainless steel combi kitchen

112 Kitchenette

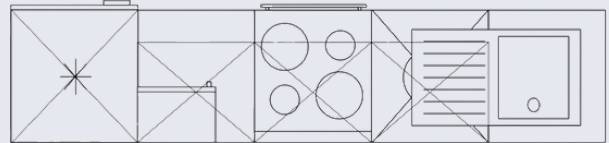

Miscellaneous



Swivel stool



Coat rack

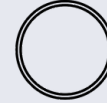

Waste paper bin



Whiteboard



Window grille

**Your reliable contact
in the region!**

Region Nord

T.+49 5031 9415 0
region.nord@algeco.com

Region

Milk 9 7121 26728 0
region.sued@algeco.com

Region West

T.+49 2131 3808 0
region.west@algeco.com

Central Region

T. +49 6158 82238 0
region.mitte@algeco.com

Region Ost

T.+49 34207 4050 0
region.ost@algeco.com



info@algeco.com • www.algeco.de

algeco[®]